



Food Processor PREP4YOU Cutter Mixer 2,6 Lt - Variable Speed - UK plug

ITEM # _____

MODEL # _____

NAME # _____

SIS # _____

AIA # _____



600963 (DK26VSG)

Cutter mixer 2.6 lt with stainless steel bowl, variable speed 500-3600 rpm, UK plug

Short Form Specification

Item No. _____

Table top cutter mixer. 2,6 litres, stainless steel bowl with scraper and central feed hole for adding products in mid-cycle. Transparent copolyester lid. Microtoothed blade rotor. Angled blades and conical base of the bowl ensure consistent mixing. All ingredients are processed evenly and quickly thanks to a special flow generated inside the bowl. No-volt release system prevents accidental start of the appliance. All parts in contact with food are removable and Dishwasher safe. Waterproof, easy to clean, flat, soft-touch buttons. Variable speed with 9 levels (500 to 3600 rpm) for extra smooth results and emulsifying. With UK plug.

Main Features

- Tabletop cutter mixer and emulsifier allowing fast chopping, mixing, mincing, griding, liquidizing and kneading.
- Includes 2,6 liter stainless steel bowl with micro-toothed blades rotor.
- Bowl/lid scraper included for uniform smooth results (emulsifying) and continuous working.
- Transparent lid, with funnel shaped hole, to add ingredients during use.
- All ingredients are processed evenly and quickly thanks to a special movement generated inside the bowl.
- Easy to clean and waterproof control panel with flat on/off button and pulse function.
- Pulse function for coarse chopping.
- All parts in contact with food are removable without the use of tools, completely dismountable and dishwasher safe.
- Productivity up to 50 settings per service.
- 9 speed levels for extra smooth results and high speed emulsifying.

Construction

- Bowl in AISI 304 stainless steel.
- Micro-toothed blades in 420 AISI stainless steel and ergonomic scraper in resistant composite material to ensure consistent mixing.
- compact design, easy to move and store.
- IPX5 (IP55) waterproof, flat, touch-control panel.
- Main switch ON/OFF on the back of the appliance.
- Asynchronous industrial motor with no brushes for high reliability and quiet functioning, stainless steel motor shaft.
- Variable speed: 500 - 3600 rpm.
- Motor power: 750 Watt.
- Food safety assured in accordance to European directives and UK legislation. In addition, materials in contact with food, are BPA-free.
- Product safety conform to European directives, UK legislation and international health and safety standards.

APPROVAL: _____



Food Processor PREP4YOU Cutter Mixer 2,6 Lt - Variable Speed - UK plug

Included Accessories

- 1 of Transparent lid for 2,6lt cutter mixer bowl PNC 650117
- 1 of Microtoothed blade rotor for 2.6lt Cutter Mixer PNC 650226
- 1 of Stainless steel bowl for 2,6lt Cutter Mixer PNC 650228
- 1 of Scraper for 2.6lt Cutter Mixer bowl PNC 650230

Optional Accessories

- Transparent lid for 2,6lt cutter mixer bowl PNC 650117
- Transparent lid without sealing for 3,6lt Cutter Mixer bowl (1 speed models) PNC 650118
- Microtoothed blade rotor for 2.6lt Cutter Mixer PNC 650226
- Smooth blade rotor for 2.6lt Cutter Mixer PNC 650227
- Stainless steel bowl for 2,6lt Cutter Mixer PNC 650228
- Transparent copolyester bowl for 2,6lt Cutter Mixer PNC 650229
- Scraper for 2.6lt Cutter Mixer bowl PNC 650230
- Stainless steel bowl for 2,6lt Cutter Mixer, microtoothed rotor, lid with scraper PNC 650231
- Microtoothed blade rotor for 3.6lt Cutter Mixer PNC 650233
- Smooth blade rotor for 3.6lt Cutter Mixer PNC 650234
- Stainless steel bowl for 3.6lt Cutter Mixer PNC 650235
- Scraper for 3.6lt Cutter Mixer bowl PNC 650236
- Transparent bowl for 2,6lt cutter mixer, microtoothed rotor, lid with scraper PNC 650245
- Stainless steel bowl for 3,6lt Cutter Mixer, microtoothed rotor, sealed lid with scraper PNC 653864



Food Processor
PREP4YOU Cutter Mixer 2,6 Lt - Variable Speed - UK plug
The company reserves the right to make modifications to the products
without prior notice. All information correct at time of printing.

2026.02.10



Food Processor PREP4YOU Cutter Mixer 2,6 Lt - Variable Speed - UK plug

Front

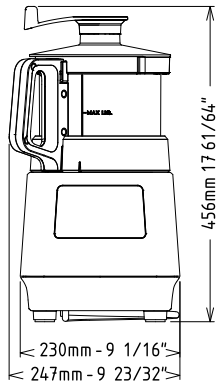

Side

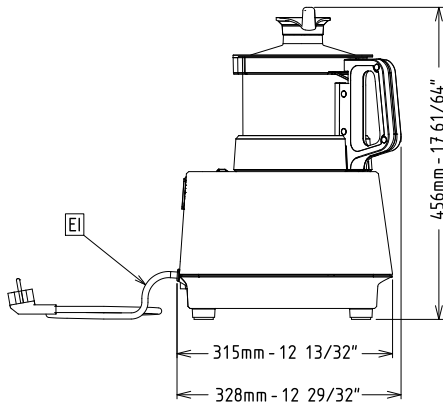

EI = Electrical inlet
(power)

Top

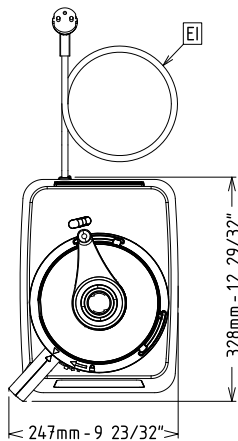

Electric	
Supply voltage:	220-240 V/1N ph/50/60 Hz
Electrical power, max:	0.75 kW
Total Watts:	0.75 kW
Capacity:	
Performance (up to):	0 kg/Cycle
Capacity:	2.6 litres
Key Information:	
External dimensions, Width:	247 mm
External dimensions, Depth:	328 mm
External dimensions, Height:	456 mm
Shipping weight:	18.7 kg
Meat mincing capacity:	0 kg
Mayonnaise preparation capacity:	0 kg
Pastry preparation capacity:	0 kg



Food Processor
PREP4YOU Cutter Mixer 2,6 Lt - Variable Speed - UK plug
The company reserves the right to make modifications to the products
without prior notice. All information correct at time of printing.

2026.02.10